

Installation and Operating Guide

Photovoltaik Module Production Series AC

ENERGY FOR A BETTER WORLD



INDEX

1	GENERAL RULES AND SAFETY PRECAUTIONS	3
2	INSTALLATION ASSEMBLY RULES	4
2.1	Assembly Notes	4
2.2	Assembly Variants.....	5
2.3	Cabling.....	6
2.4	Grounding	7
2.5	Proper Operation	7
2.6	Other Specifications.....	7
2.7	Fire Protection.....	8
2.8	Maintenance and Cleaning.....	8
2.9	Product Identification.....	8
2.10	Notes	9
3	DISCLAIMER	9
4	CE/EG DECLARATION OF CONFORMITY	10

1 General Rules and Safety Precautions

The glass surfaces must not be damaged or scratched. In particular, the rear of the module must not be exposed to mechanical impacts (e.g. by sharp, hard objects).

Do not stand on the modules or module frames.

The solar modules must not be installed under bending tension and the frame parts must not be twisted in themselves during assembly.

The solar module must not be compressed along its sides.

Marine and mobile applications are generally excluded.

Before the start of the installation of the PV system, the advice of the relevant authorities as well as the energy provider regarding regulations, guidelines and approval requirements must be obtained. These are to be followed during installation. All applicable local, regional and national statutory orders and regulations are to be observed.

The electrical connection of the individual modules with each other and the connection to the inverter must be made with the same type of plug-in connectors that are pre-installed on the modules. The cables must not be used as a carrying aid or folded and must not be installed under tension.

The electrical installation and commissioning must only be carried out by a qualified electrician who knows the relevant standards and regulations for the use and assembly of solar modules. This includes in particular the relevant DIN standards, VDE and VDEW guidelines.

An improper execution during installation or commissioning can result in personal injuries or damage to the modules. Our operating instructions do not enable persons lacking the aforementioned knowledge to assemble the solar module.

It is advisable to provide for service access during project planning.

Protective goggles and safety shoes are to be worn at all times when performing the work. If applicable, observe the regulations and recommendations of the relevant trade associations or corresponding bodies. Work on the photovoltaic system must not be performed in rain, snow or wind. The glass surface and module frame can become hot when exposed to sunlight and there is a risk of burns. Use gloves, if applicable.

For safety reasons, defective modules must be replaced immediately.

The photovoltaic modules from AXITEC described herein meet the requirements of application class A, that is, dangerous voltage (IEC 61730: greater than 50 V DC; EN 61730: greater than 120 V DC) and systems with dangerous power output, where unrestricted accessibility is to be expected.

Further information about modules from AXITEC can be found in the datasheets for the modules. The datasheets are available via the Internet at www.axitecsolar.com.

Due to special environmental conditions, a module may supply a higher current and/or voltage than specified under the standardised test conditions. When designing PV systems, the values for I_{sc} and U_{oc} should be multiplied by a factor of 1.25 to determine the nominal values for components such as, e.g., cabling, fuses and inverters which will be connected to the output of the modules.

2 Installation Assembly Rules

2.1 Assembly Notes

Modules must be handled with care during installation. Impacts to the front and rear or the edges can damage the modules.

For a roof assembly, ensure that the structural dimensions (consult a structural engineer, if applicable) of the roof are adequate for bearing the loads imposed by the photovoltaic system.

We recommend positioning the solar modules at an angle of at least 10° to a maximum of 75° to the ground. Struts, mounting clamps, screws and other fixing elements must be commercially available and corrosion-free and must fulfill the requirements of DIN 1055. In particular, the fixing elements must be designed in accordance with the local wind and snow loads to DIN 1055-4 and 1055-5.

The modules are to be mounted in such a way that melt- and rainwater can run off freely and that the module will not be constantly wet.

The solar modules are suitable for installation both with their long side up and their short side up. (see 2.2 Assembly Variants)

Take note of the position of the connection socket.

When using mounting clamps, the solar modules are to be mounted on the struts in at least four locations on opposite sides. The clamps must be positioned inside the mounting zone.

The module must be securely fixed. The clamps must not be in contact with the front glass or deform the frame in any way.

Avoid shading effects from the clamps and mounting system.

Module can be mounted with bolts at 4 (four) or 8 (eight) symmetrical quarter points.

The modules must be mounted with a minimum distance of 5 mm to the next module.

Use corrosion-proof mounting materials.

Do not drill any holes into the module and module frame.

The maximum tightening torque for the mounting clamps and bolts is 14 Nm.

In order not to impair the modules' energy yield, their installation in shaded areas (by trees, buildings, etc.) is to be avoided.

An installation of the modules as overhead glazing is not permitted.

Modules should only be installed in such a way that sufficient back ventilation is ensured.

Modules become warm and require an adequate air flow for cooling.

Water drainage openings in the module frame must not be closed in any way. The mounting frame, too, must not obstruct them.

The earthing holes provided only serve for the purpose of earthing the frame.

Operation of the solar modules in regions with snow loads of up to 5400 Pa is dependent on the assembly and module type (see 2.2 Assembly Variants).

Ensure that no flammable gases can occur near the installation site.

In a roof installation, the module must only be mounted above a fireproof roof cover approved for this application.

2.2 Assembly Variants

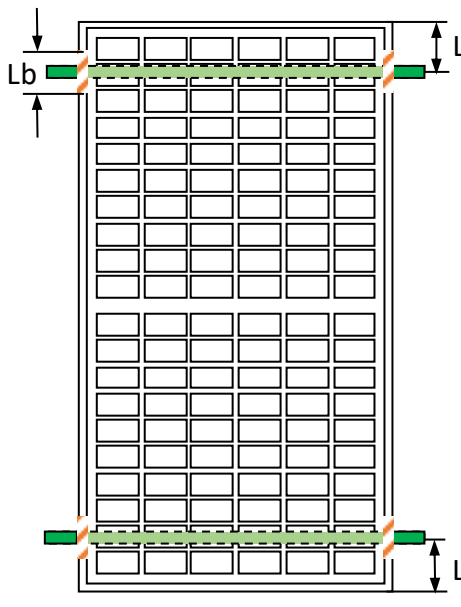
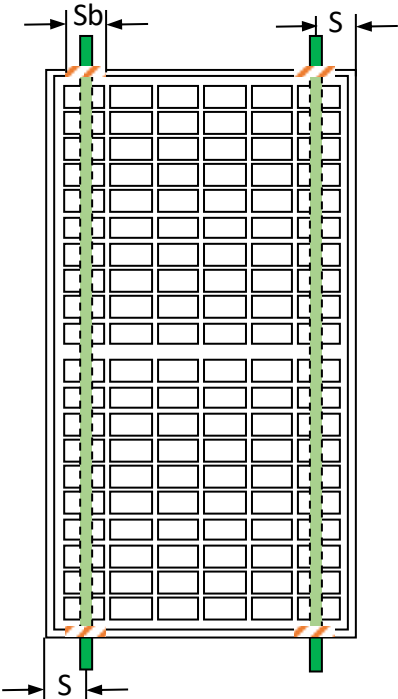
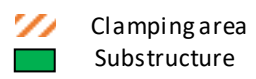
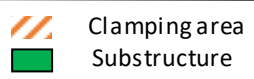
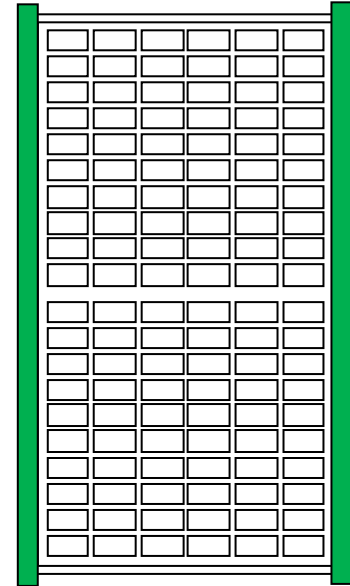
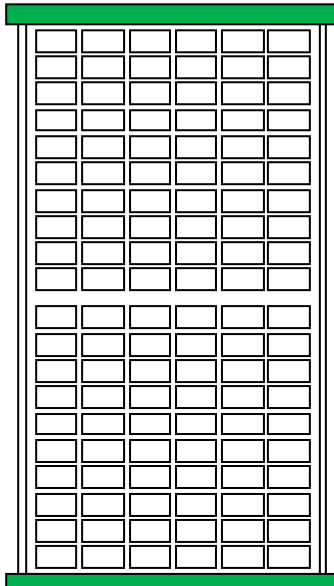
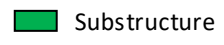
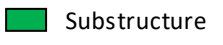
<p>Mounting method: 60/72ce 120/144ce halfcut</p>	<p>Installation with clamps, long side</p>	<p>Installation with clamps, short side</p>
		
<p>Comment</p>		
<p>Mounting method: 60/72ce 120/144ce halfcut</p>	<p>Installation with inlay system, long side</p>	<p>Installation with inlay system, short side</p>
		
<p>Comment</p>		

All drawings are schematic diagrams and do not match reality.

Installation with mounting rails (clamps)				
	Clamping range			
	long side		short side	
	L (mm)	Lb (mm)	S (mm)	Sb (mm)
60 cells Cell geometry 6 x 10 cells 120 cells Cell geometry 6 x 20 halfcut cells	250 - 450	100	35 - 300	265
Loading capacity	5400 Pa		2400 Pa	
72 cells Cell geometry 6 x 12 cells 144 cells Cell geometry 6 x 24 halfcut cells	300 - 500	100	forbidden	forbidden
Loading capacity	2400 Pa		0 Pa	

2.3 Cabling

Connect the number of modules that corresponds to the voltage specifications of the devices used in the system. The modules (in accordance with protection class II) must not be operated with a higher voltage than the permitted system voltage. The specifications can be found in the datasheet of the modules or in the datasheet of the relevant inverters. Please ensure that the cables are installed and fixed in such a way that, in particular, the plug-in connections do not lie in a water-carrying plane.

The specified protection classes are to be observed, however, the minimum compliance required is IP65. Ensure a gapless connection when connecting the plug-in connectors.

Disconnecting the module connections during operation can result in light arcs (break sparks) and therefore in a hazard for people and equipment. Do not insert any objects into the plugs and sockets!

For a series connection, only modules with the same current rating should be used, and for a parallel connection, only modules with the same voltage rating should be used.

Suitable overcurrent protection measures (e.g. string cut-out) are required for the parallel connection of the modules. It must be ensured that the specified capacity regarding the return current, IR, of 16 A will not be exceeded.

In a shaded system the modules or module strings should be connected in parallel.

Only use special solar cables and suitable plugs. Attach the cables to the mounting system using UV-resistant cable ties and avoid exposing the cables to direct sunlight.

2.4 Grounding

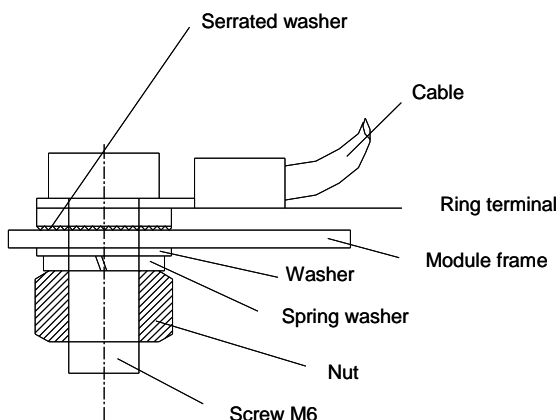

Proper earthing is the responsibility of the company carrying out the installation and is to be attached to the module frame. If a lightning protection system is already present or intended to be installed on the building, the PV system is to be integrated into the protection concept against direct lightning strike. It is recommended to provide potential compensation on the frame when using an inverter without a transformer. Earth is indicated on the module frame. The earthing holes must remain unobstructed and must not be covered.

The recommended cross-section of the cable is 4 mm². Only certified cables must be used for earthing and module connection. The minimum bending radius is 5x the cable diameter.

Country-specific standards are to be adhered to.

The connection of the inverter to the module arrays must be carried out properly and to professional standards.

2.5 Proper Operation

If the modules are installed according to the instructions above, the system components must result in a proper operation of the modules. If the modules are not operated properly, the warranty can become void or at least significantly limited.

2.6 Other Specifications

- The modules must be installed in an environment in which it is ensured that the operating temperature range will not exceed or fall below -40°C to +85°C. Sufficient air circulation behind the modules should particularly be ensured in hot environments.
- Modules must not be operated under short-circuit conditions.
- All shading of the module array is to be avoided.
- The modules must not be immersed in water.
- Do not artificially bundle sunlight by means of mirrors, lenses or other devices onto the module.
- Earthing of the modules shall only be carried out at the locations on the frame profile specified for this purpose via an earth cable that is connected electrically conductive with the frame.
- If the modules are assembled near the sea, a minimum distance of 200 m to the coastline must be ensured.

- In order to reduce voltages caused by lightning strikes, the surface area of all conductor loops must be as small as possible. Modules shall be installed in such a way that sufficient air circulation will be possible to prevent an overheating of the modules and components.
- All connected electrical components must be designed for the maximum operating voltage of the system.

2.7 Fire Protection

- For questions regarding building safety and prevention of fires on buildings please contact the relevant local authority.
- If applicable, use earth fault switches or fuses in accordance with the specifications of the local authorities.
- Do not use modules near devices or places where flammable gases may be formed.
- The modules are assigned to fire class C and are suitable for installation on roofs of class A.

2.8 Maintenance and Cleaning

Given a sufficient inclination ($\geq 15^\circ$), the modules will generally require no cleaning (self-cleaning through rain). In case of heavy dirt deposits, cleaning with water without cleaning agents and with a gentle cleaning implement (sponge without hard surface) is recommended. In no case must dirt deposits be scraped off dry with any object as this can cause microscopic scratches.

We recommend regular inspections:

- Regularly check the module for signs of damages and glass breakage
- Check that all electrical connections are secure and free of corrosion
- Check that the cables are undamaged
- Check that the mounting system is securely attached and firm

The most common causes for a low energy yield are:

- Improper or faulty wiring
- Burned-out fuses or triggered power switches
- Shading of the modules by trees, masts or buildings
- Failure of the inverter
- Improper maintenance and cleaning
- Build-up of dirt on the modules
- Unsuitable angle of inclination or alignment of the modules

2.9 Product Identification

Each module has three labels

- **1x type label:**
Describes product type, nominal power, nominal current, nominal voltage, no-load voltage, short-circuit current (measured under standard test conditions (STC), the measurement tolerance is +/-3%), weight, dimensions, etc. The maximum system voltage is 1000 V DC.

- **2x serial number/barcode:**

Each module has a unique serial number encoding, among other details, the year and month of manufacture. One serial number label is permanently fitted on the front below the glass and the second on the rear below the type label.



It is not permitted to remove or cover labels. Removing or covering the labels will void the AXITEC warranty.

2.10 Notes

AXITEC Energy GmbH & Co. KG reserves the right to make unannounced alterations to the design and/or technical specifications of its solar modules at any time. Therefore, only the datasheet current at the time of manufacture is definitive. It is therefore expressly recommended to ensure that the datasheets on hand represent the current status before placing an order. When performing assembly or other work on the solar modules, the datasheets and user information current at the time of manufacture of the relevant module are to be used for reference. The contents of older or newer documents may be incorrect due to interim product changes.

This version of “Installation & Operating Instructions” replaced all other before.

3 Disclaimer

These installation and assembly instructions apply to generally common systems. All specifications are provided without warranty. AXITEC Energy GmbH & Co. KG does not guarantee the modules' fitness for use or function in case of any deviation from the notes contained in this user information. Because the adherence to this user information and the conditions and methods of the installation, the operation, the use and the maintenance of the modules cannot be controlled or monitored by AXITEC Energy GmbH & Co. KG. AXITEC Energy GmbH & Co. KG accepts no liability for damages caused by any use other than the intended use, faulty installation, operation, use or maintenance.

Furthermore, any liability for violations of patent rights or violations of other rights of third parties arising from the use of the modules is excluded, provided there is no liability obligation to this effect imposed by law.

4 CE/EG Declaration of conformity

CE/EG-Konformitätserklärung CE/EG-Declaration of conformity IEC 61215 & IEC 61730

Hiermit erklären wir,
Herewith we declare,

dass die Solarmodule der AXITEC-Reihe AC
that the modules of the AXITEC-series AC

die Bestimmungen der Richtlinie 2014/35/EU auf Basis der Einhaltung der
Normen: IEC 61215 und IEC 61730 vollständig erfüllen.
are in compliance with the essential requirements of the EU-Directives
2014/35/EU based on the compliance of the IEC-Standards IEC 61215 and
IEC 61730.

Die Bestimmungen der Schutzklasse II sind Bestandteil der Norm IEC 61730.
The regulations of safety class II is part of the IEC-Standard IEC 61730.

Böblingen, 20.04.2016

Axitec Energy GmbH & Co. KG
Otto-Lilienthal-Straße 5
D-71034 Böblingen
energy@axitecsolar.com
www.axitecsolar.com

Steffen Wiedmann
CEO

Hinweis :

Diese Konformitätserklärung verliert ihre Gültigkeit, wenn das Produkt ohne ausdrückliche Zustimmung der Axitec Energy GmbH & Co. KG umgebaut, ergänzt oder in sonstiger Weise verändert wird. Das gilt auch für den Fall eines unsachgemäßen Anschlusses oder nicht bestimmungsgemäßer Verwendung.

Notice :

Alterations, extensions or other changes made to the product without the explicit consent of Axitec Energy GmbH & Co. KG will void this declaration of conformity. This also applies for the case of incorrect installation or other improper use.